

Sonderformen in Originalgrößen - Preisgruppe A

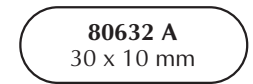
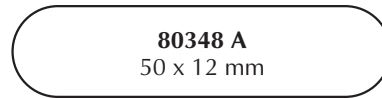
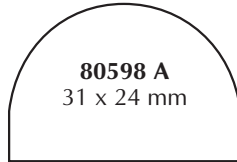
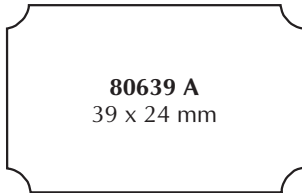
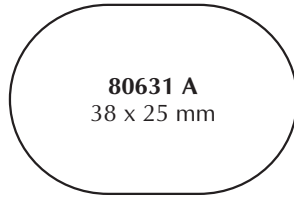
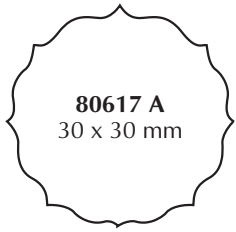

Rechteckformen mit spitzen Ecken in Originalgröße

Größen:

- 80078 A - 12 x 5 mm
- 80339 A - 20 x 30 mm
- 80524 A - 22 x 22 mm
- 80590 A - 22 x 38 mm
- 80611 A - 25 x 20 mm
- 80575 A - 25 x 25 mm
- 80544 B - 37 x 34 mm
- 80629 A - 40 x 17 mm
- 80507 A - 44 x 12 mm
- 80562 A - 50 x 20 mm
- 80608 B - 50 x 25 mm
- 80593 B - 50 x 50 mm
- 80180 B - 65 x 25 mm
- 80568 B - 70 x 30 mm
- 80578 C - 70 x 60 mm
- 80148 B - 80 x 20 mm
- 80255 C - 80 x 60 mm
- 80105 B - 90 x 10 mm
- 80491 B - 90 x 20 mm
- 80624 C - 100 x 60 mm
- 80625 D - 143 x 90 mm
- 80455 B - 145 x 10 mm
- 80453 B - 145 x 20 mm

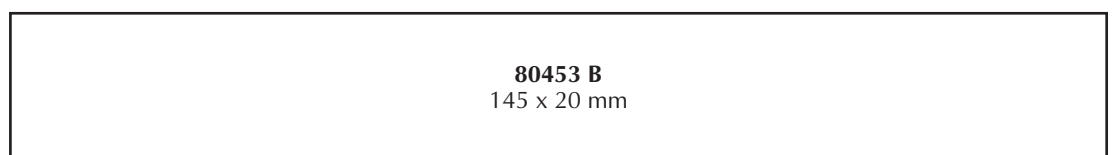
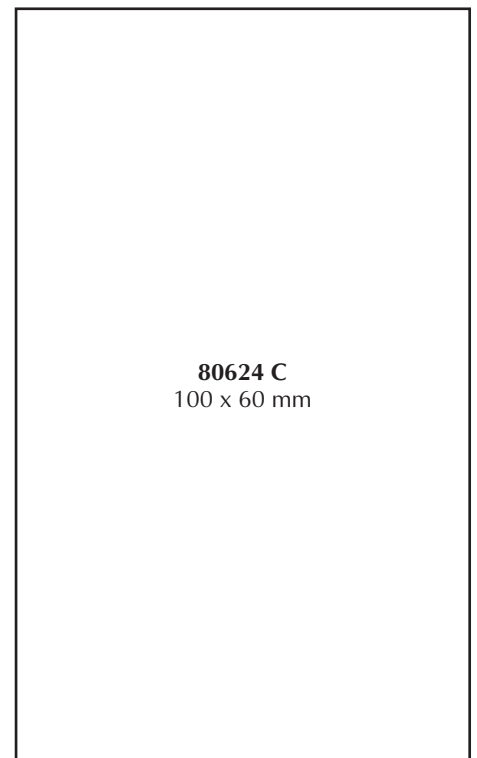
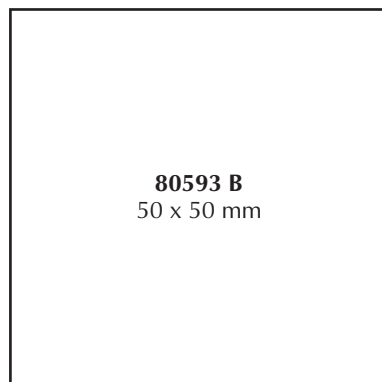
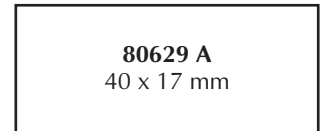
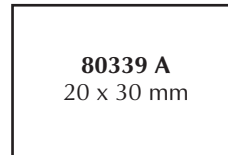
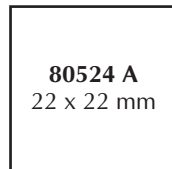

Sonderformen in Originalgrößen - Preisgruppe B

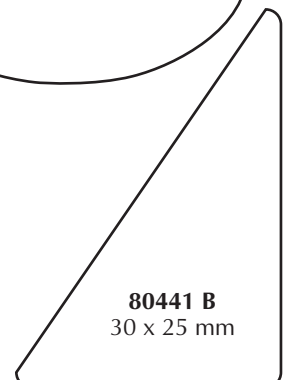
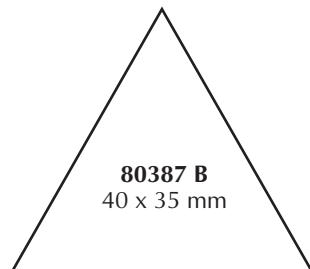
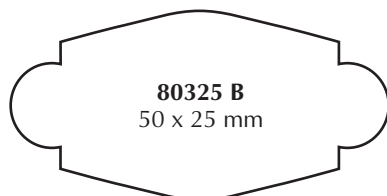
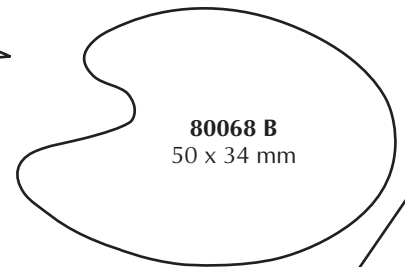
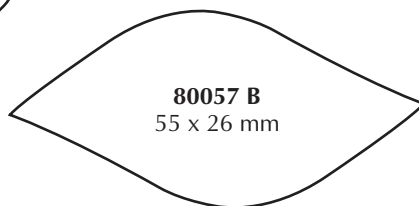
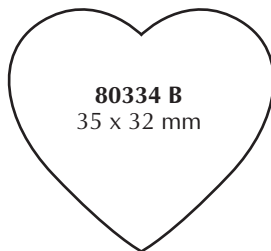
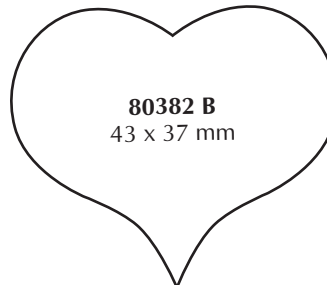
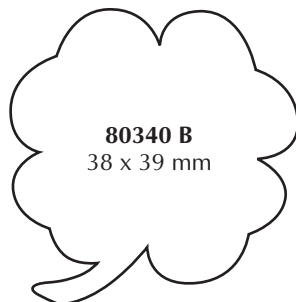
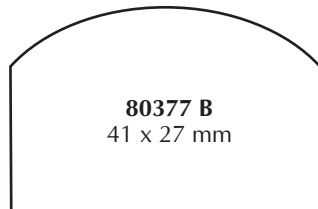
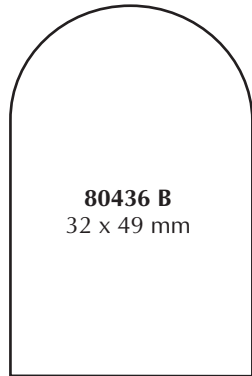
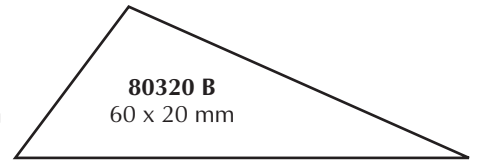
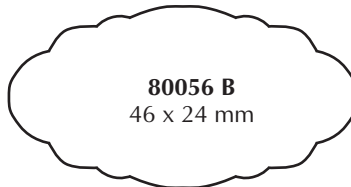
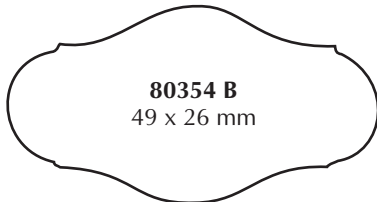
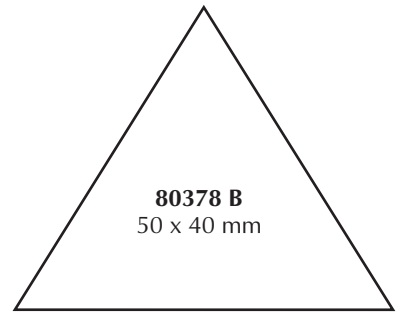
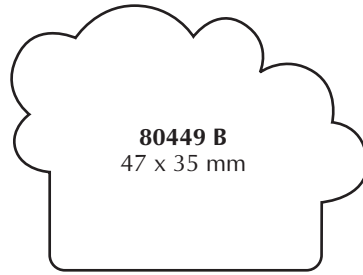
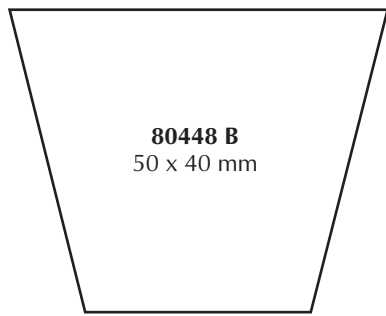

Sonderformen in Originalgrößen - Preisgruppe B

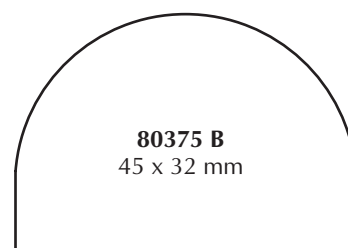
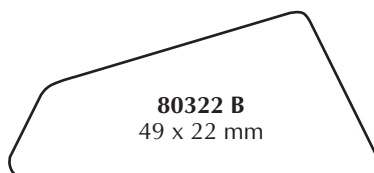
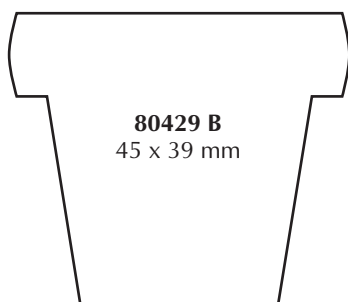
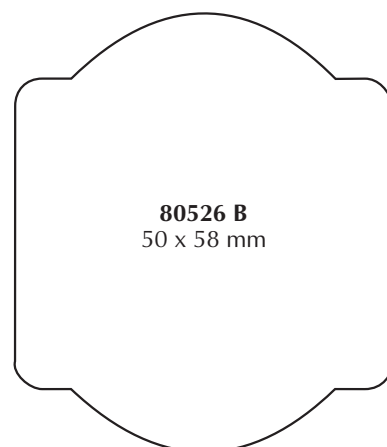
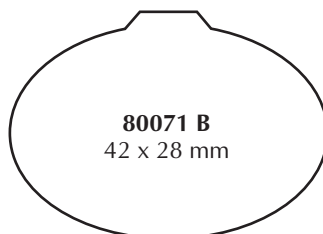
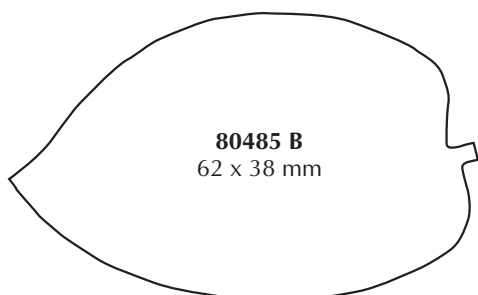
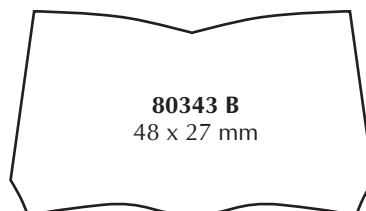
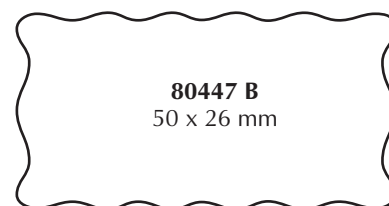
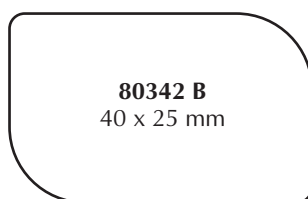
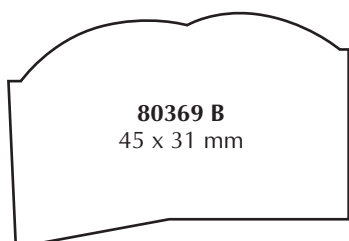
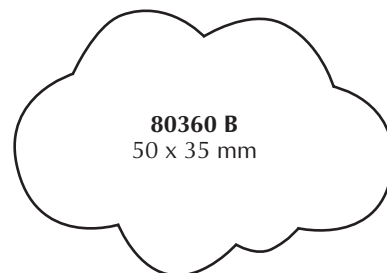
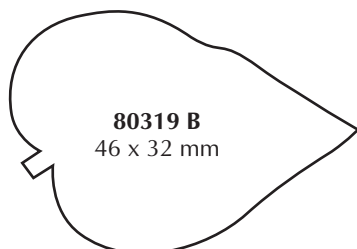
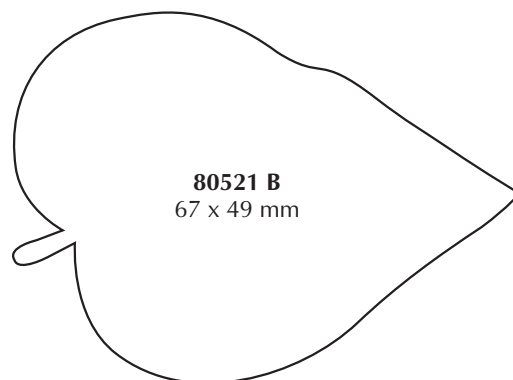
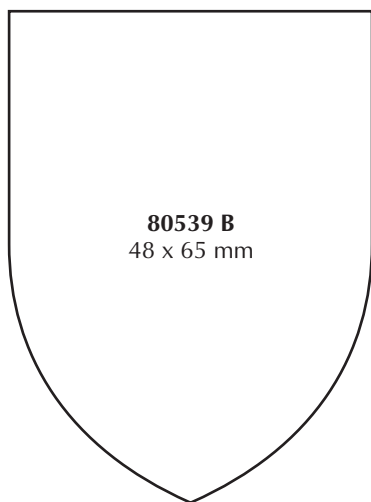

Sonderformen in Originalgrößen - Preisgruppe B

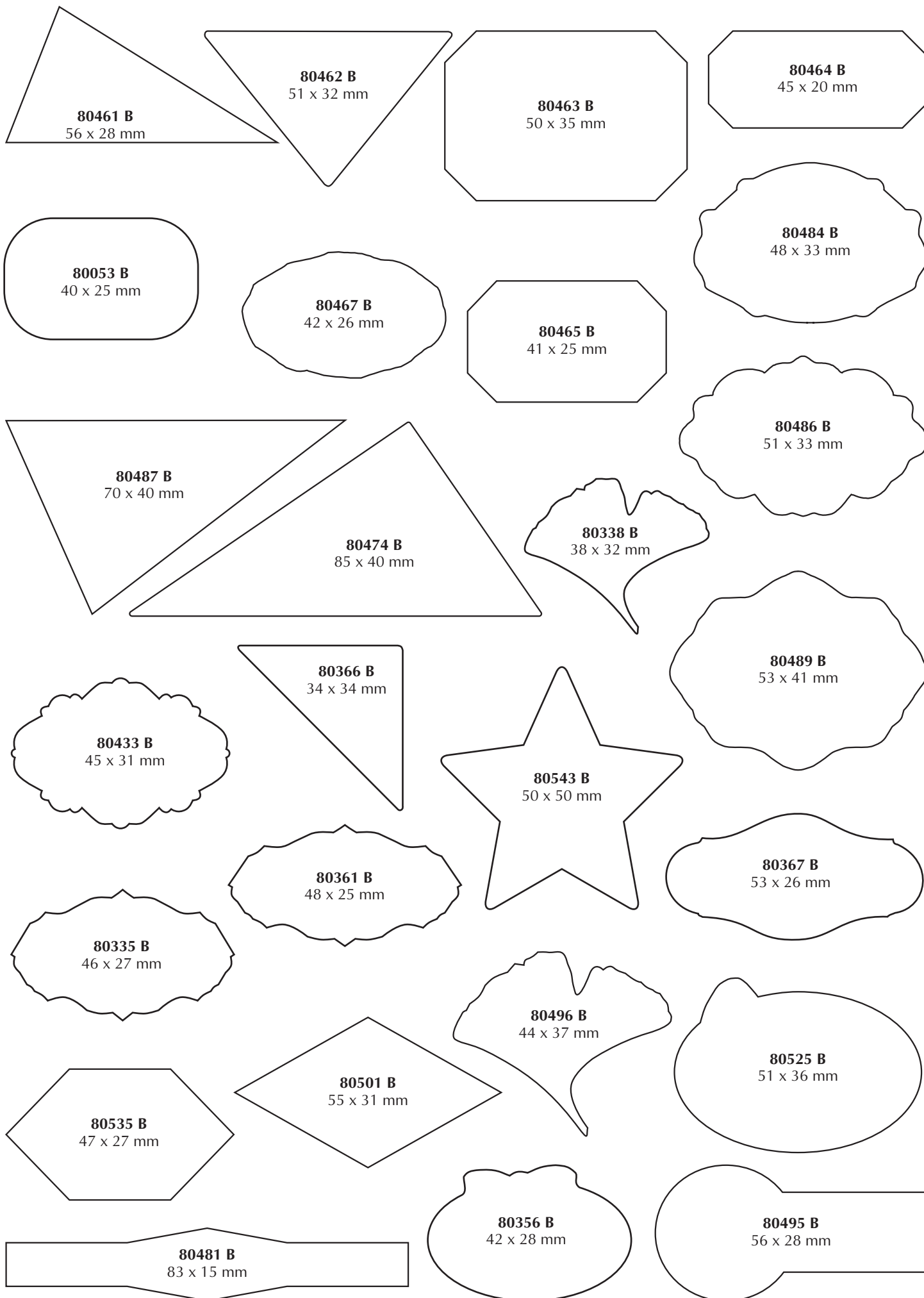

Sonderformen in Originalgrößen - Preisgruppe B

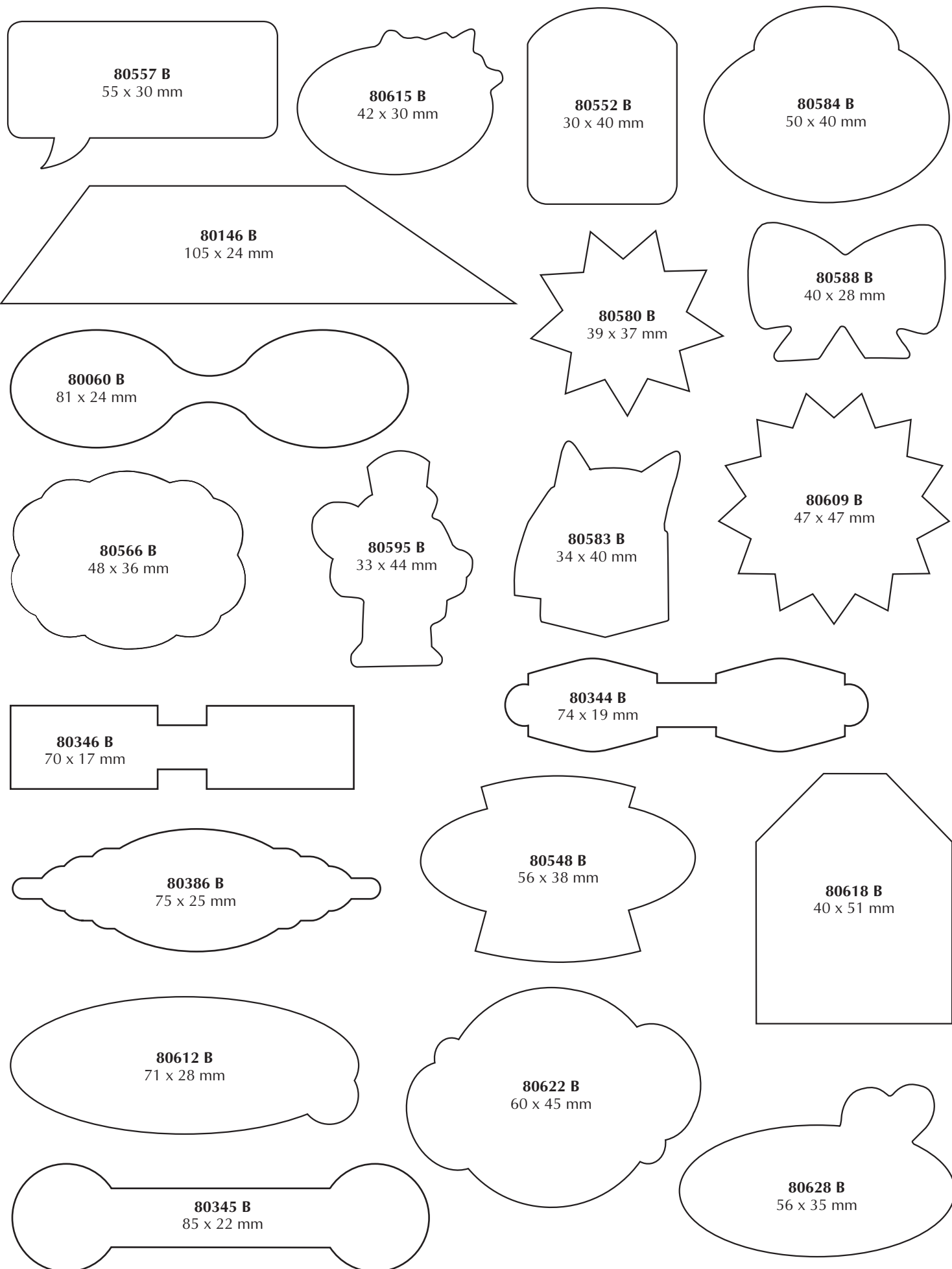

Wir führen über 500 Standard-Etiketten in vielen Qualitäten und Ausführungen.

Sonderformen in Originalgrößen - Preisgruppe C

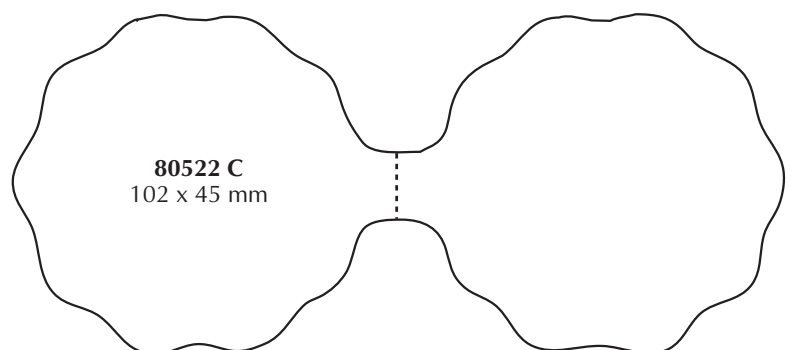
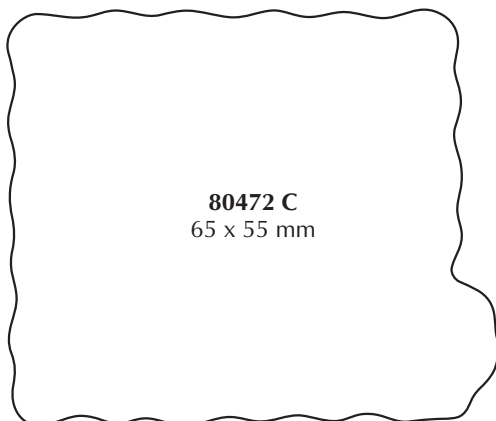
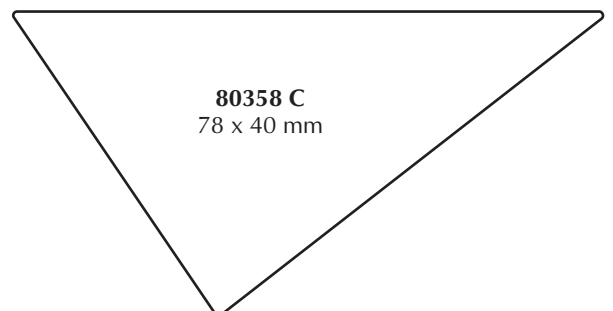
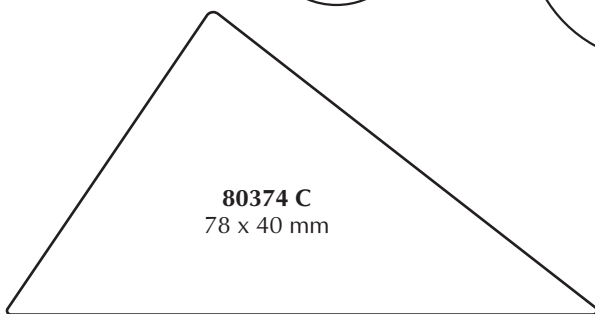
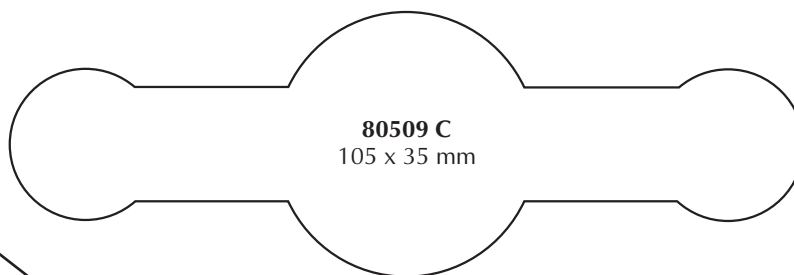
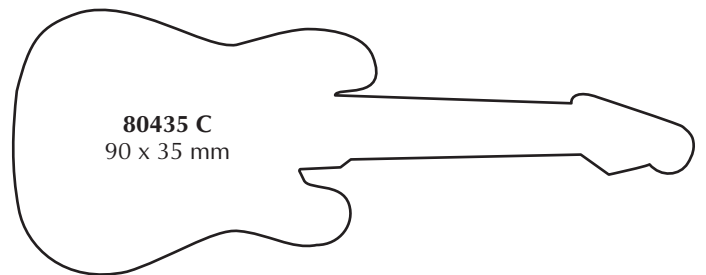
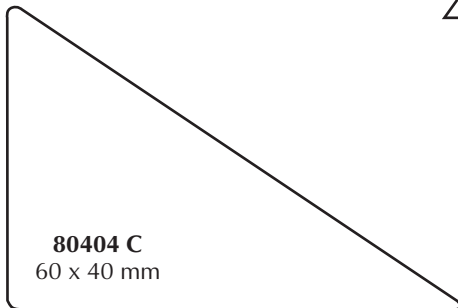
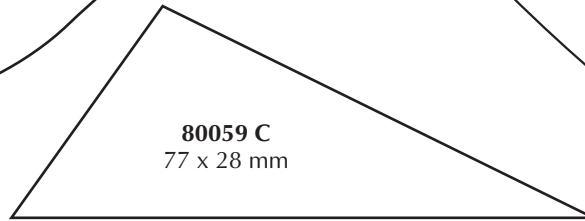
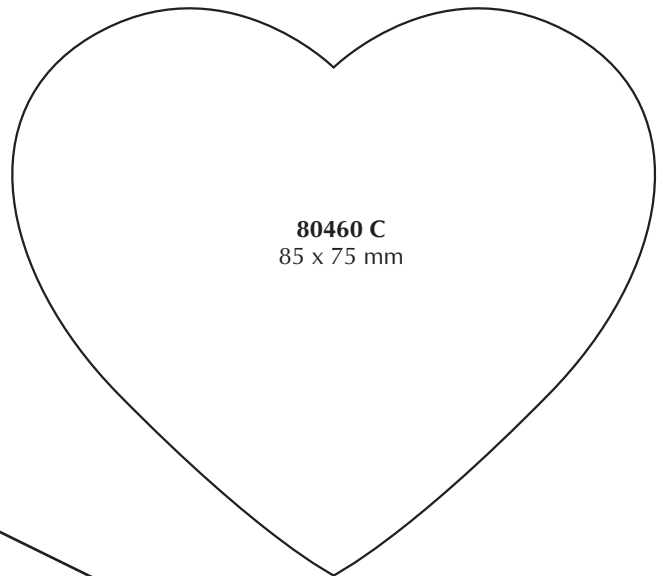
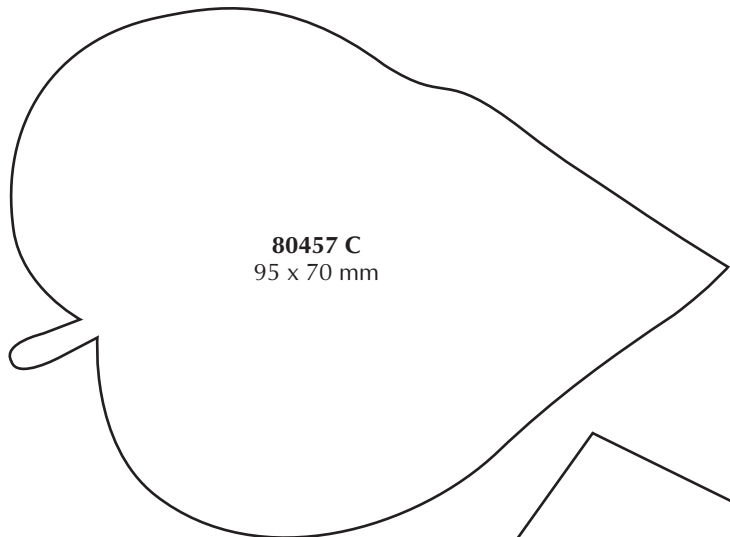

Sonderformen in Originalgrößen - Preisgruppe C

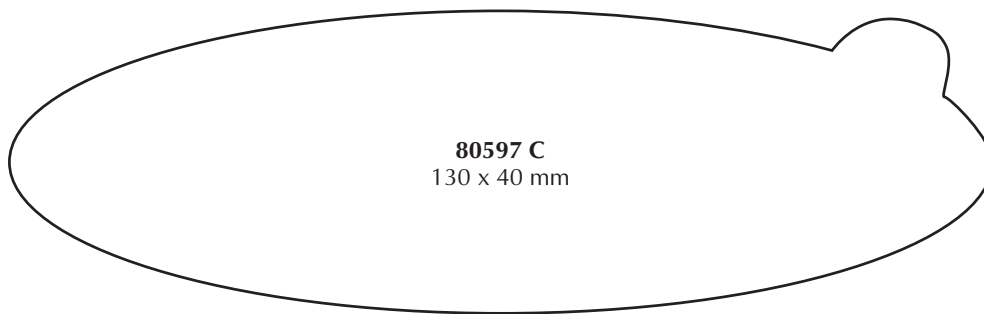
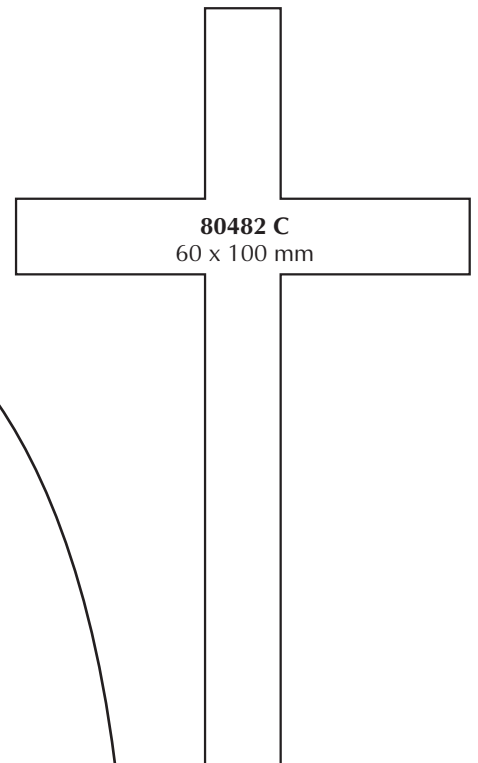
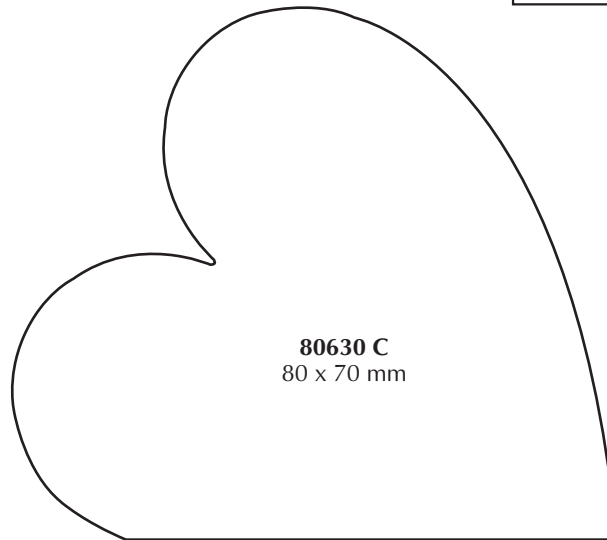
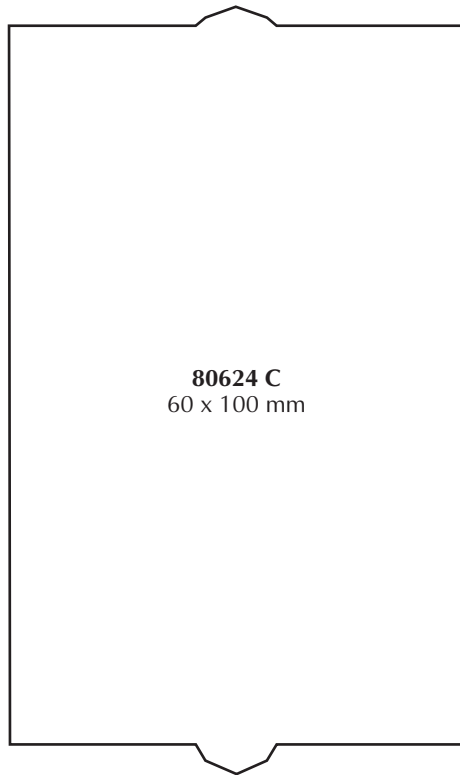

Sonderformen in Originalgrößen - Preisgruppe D

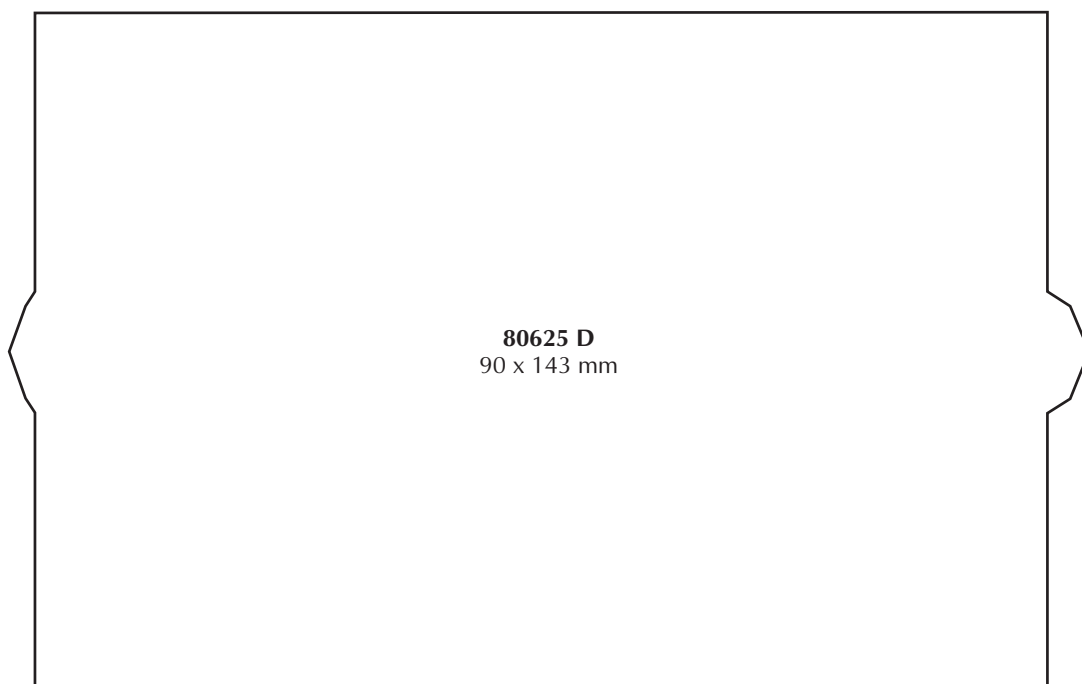

Preise per 1.000 Stück, 1-farbig bedruckt

bei Abnahme von	Form A	Form B	Form C	Form D
1.000 Stück	€ 74,90	€ 82,30	€ 108,00	€ 149,50
2.500 Stück	€ 37,90	€ 43,90	€ 67,30	€ 84,80
5.000 Stück	€ 29,10	€ 32,60	€ 58,50	€ 73,10
10.000 Stück	€ 21,80	€ 23,90	€ 48,20	€ 64,40
über 10.000 Stück	Preise auf Anfrage			

Einmalige Klischeekosten **€29,50** pro Farbe
(entfallen bei Zusendung
eines vorhandenen
Etikettes)



Ein handlicher
Spenderkarton
wird kostenfrei
mitgeliefert.

Mehrpriis pro weitere Druckfarbe 20 %. Drei- und Mehr-Farbedruck ab 2.500 Etiketten. Klischee- oder Farbwechsel € 12,00.
Die Lieferung erfolgt einschliesslich Verpackung, ab € 1.000,- Warenwert frei Haus, darunter zuzüglich € 9,90 Versandkosten.
Alle angegebenen Preise verstehen sich netto, zuzüglich Mehrwertsteuer.

Papiersorten - matt

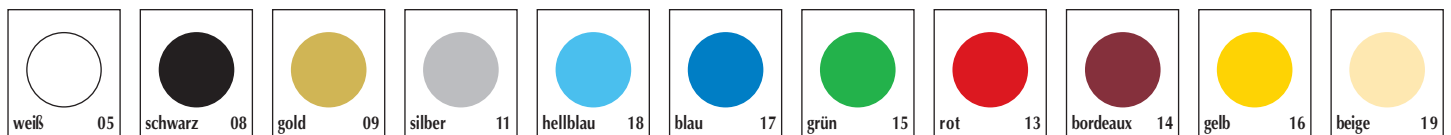

Papiersorten - glänzend

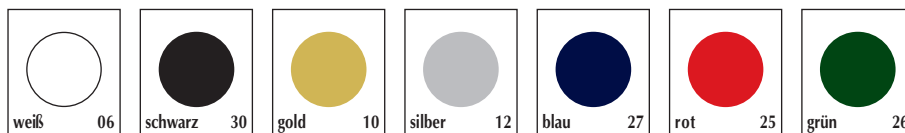

Kraftpapiere



Fluorpapiere

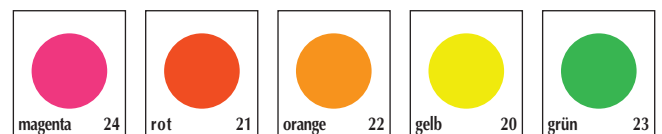

Sonderpapiere

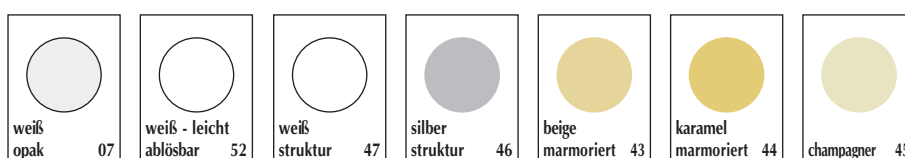

Polyäthylen

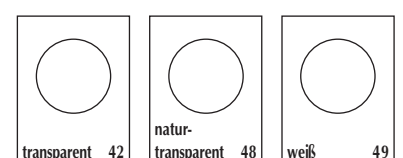

Die Darstellung der Materialfarben ist nicht verbindlich – ein Original-Farbmuster erhalten Sie auf Anforderung.

Druckfarben

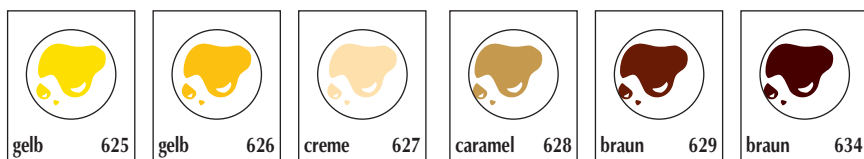
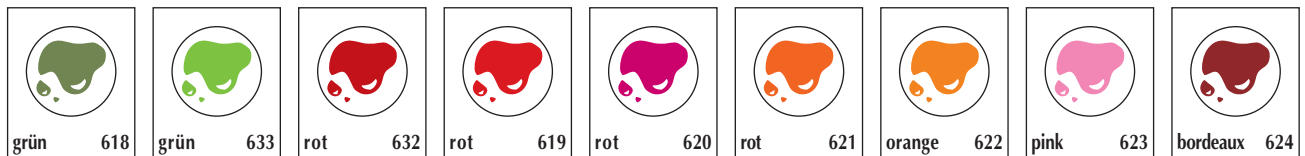

Druckfarben - metallic



Die Darstellung der Druckfarben ist nicht verbindlich – ein Original-Farbmuster erhalten Sie auf Anforderung.

